

NOTICE OF MEETING

Vancouver School Board
Secretary-Treasurer's Office
June 1, 2018

Committee III:

Joy Alexander
Fraser Ballantyne
Carrie Bercic
Ken Clement
Lisa Dominato
Janet Fraser
Estrellita Gonzalez
Allan Wong
Judy Zaichkowsky

Suzanne Hoffman, Superintendent of Schools
J. David Green, Secretary Treasurer

Notice of Meeting

A Meeting of the **Education and Student Services Committee (Committee III)** will be held in Committee Room # **180** of the Education Centre, 1580 West Broadway, Vancouver, British Columbia, on

Wednesday, June 6, 2018 at 6:00 pm

Student Trustee:	Eugene Jeoung	
District Management Staff:	Aaron Davis Pedro da Silva Mette Hamaguchi Magdalena Kassis Michele Kelly Adrian Keough Brian Kuhn Lisa Landry	Jody Langlois Patricia MacNeil Jim Meschino David Nelson Rob Schindel Shehzad Somji Richard Zerbe
Reps:	Treena Goolieff, VSTA Chloe McKnight, VESTA Damian Wilmann, VASSA Diane Martinson, VEPVPA Cheryl Douglas, PASA Amanda Hillis, DPAC Sunera Samarakoon, CUPE 15 Tim DeVivo, IUOE Stephen Kelly, Trades Brent Boyd, CUPE 407 Chloe Zhang, VDSC	Alt. Leanne Hagglund, VSTA Jody Polukoshko, VESTA Iqbal Gill, VASSA Jacquie Lavoie, VEPVPA Audrey Van Alstyne, PASA Crystal Smith, DPAC Thomas Leung, CUPE 15 Tim Chester, IUOE Raymond Szczecinski, Trades
Others:	Secretary-Treasurer's Office District Parents Chris Allen Lynda Bonvillain Communications	Ed. Centre Engineers Rentals Maisie Louie Kathie Currie, CUPE 15

COMMITTEE MEETING

COMMITTEE III – EDUCATION AND STUDENT SERVICES

Wednesday, June 6, 2018 at 6:00 pm

Room 180, VSB Education Centre

AGENDA

The meeting is being held on the traditional unceded territory of the Musqueam, Squamish and Tsleil-Waututh Coast Salish peoples.

Delegation

1. Student Presentation - Coding

Presenter

Audrey Van Alstyne, District Principal,
Learning Technology

Items Requiring Board Action/Motions

2. French Immersion Program Review
3. Board/Authority Approved Courses (BAA)

Adrian Keough, Director of Instruction

Aaron Davis, Director of Instruction

Reports for Trustee's Information

4. Special Education Review
Questions arising from report

Jody Langlois, Associate Superintendent
Mette Hamaguchi, Director of Instruction

5. School Plans Update

Rob Schindel, Associate Superintendent

6. Archives

Jody Langlois, Associate Superintendent

Information Item Requests

Date and Time of Next Meeting

September 12, 2018, 6:00 pm in Room 180

Coding & Computational Thinking

Committee III Presentation
Wednesday, June 6, 2018



We inspire student success by providing an innovative, caring and responsive learning environment.



Presenters

Wesley Peregoodoff-Marte – Student, Norma Rose Point School

Adrienne Wood - Lead Coding Teacher (VESTA)

Peter Halim - Lead Coding Teacher (VSTA)

Audrey Van Alstyne – District Principal, Learning Technologies



Announcement January 2016

Office of the Premier

Headline: \$6 million to help connect students with coding, new curriculum and computers

- “By the end of Grade 9, every student in British Columbia will take a module of basic coding under B.C.’s new curriculum. Coding is a hands-on way of teaching students how to analyze a problem, determine the steps to fix that problem and then create directions so a machine can carry out those steps.”



Strategic Plan Connections

Goal 1:

Engage our learners through innovative teaching and learning practices

Goal 2:

Build capacity in our community through strengthening collective leadership



2017/2018 Coding & Computational Thinking Workshop Series



Introduction

3 session micro:bit workshop for Grade 6 to 9 teachers.

- Designed to assist teachers in delivering ADST – Computational Thinking and Coding curriculum in their classrooms
- Over 20 participants
 - Each teacher received a class set of materials (1:1 micro:bit to student)
 - A key focus was equitable access for participating teachers' students (access to devices/supplies)
- Hosted at Vancouver Technical Secondary School
 - After school 4:00-6:00

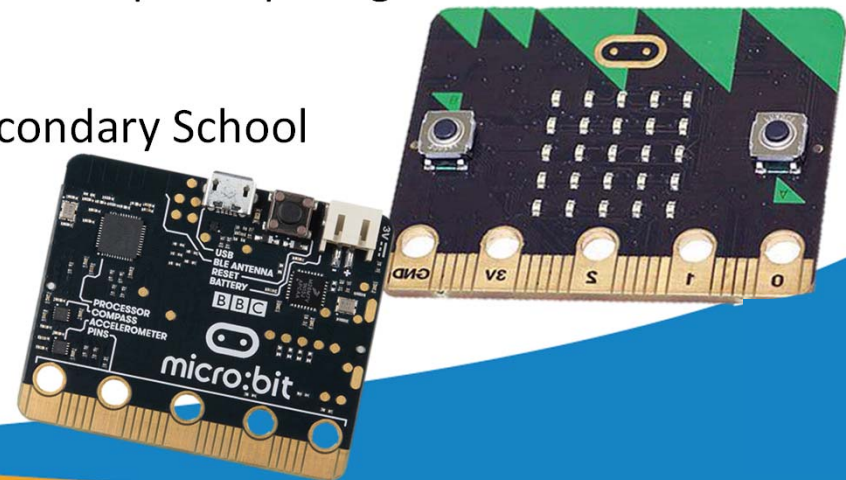

Session #1 Introduction to the micro:bit

Teachers participants were introduced to the micro:bit (how to code and implement)

Teachers programmed their micro:bits to count steps and then designed/built the micro:bit into a wearable pedometer

Teachers were given all required resources and supplies to deliver the pedometer activity/lesson in their classrooms

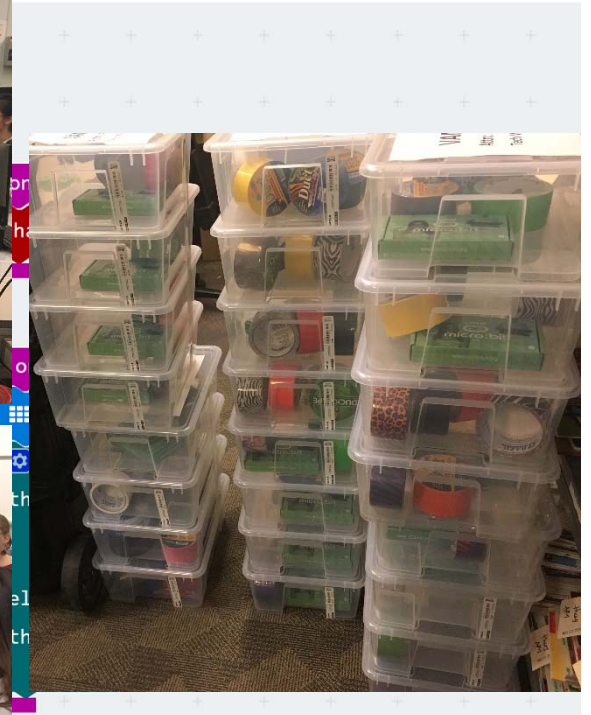
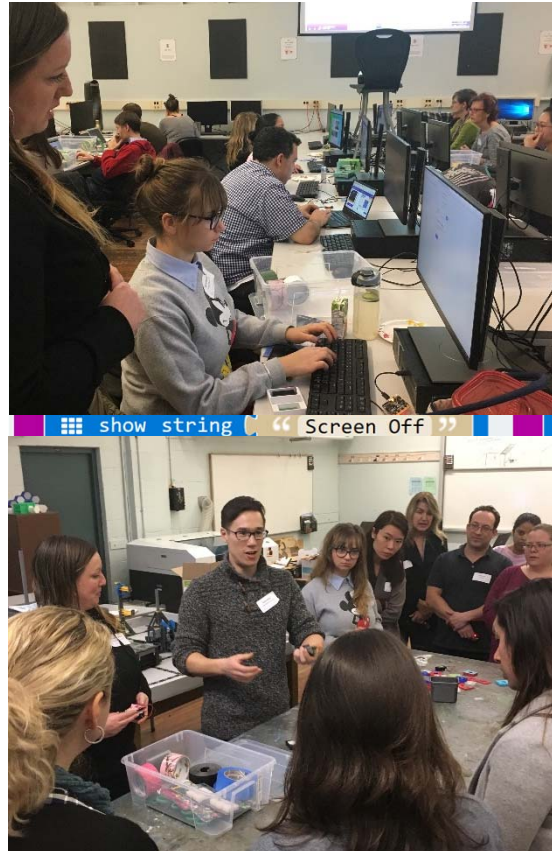

#2 - Expanding beyond the micro:bit with Making

Teachers were introduced to using inputs and outputs

Participants coded micro:bits into reaction timers, used cardboard and foil to construct a basic user interface, and used alligator clips to connect micro:bit to the interface

Participants were given all resources and supplies to deliver the reaction timer activity/lesson in their classrooms

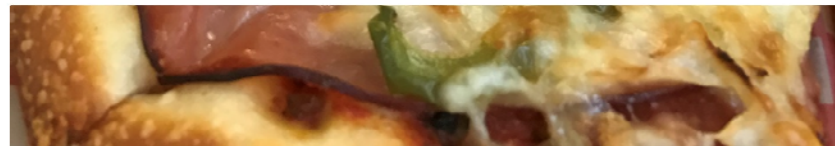
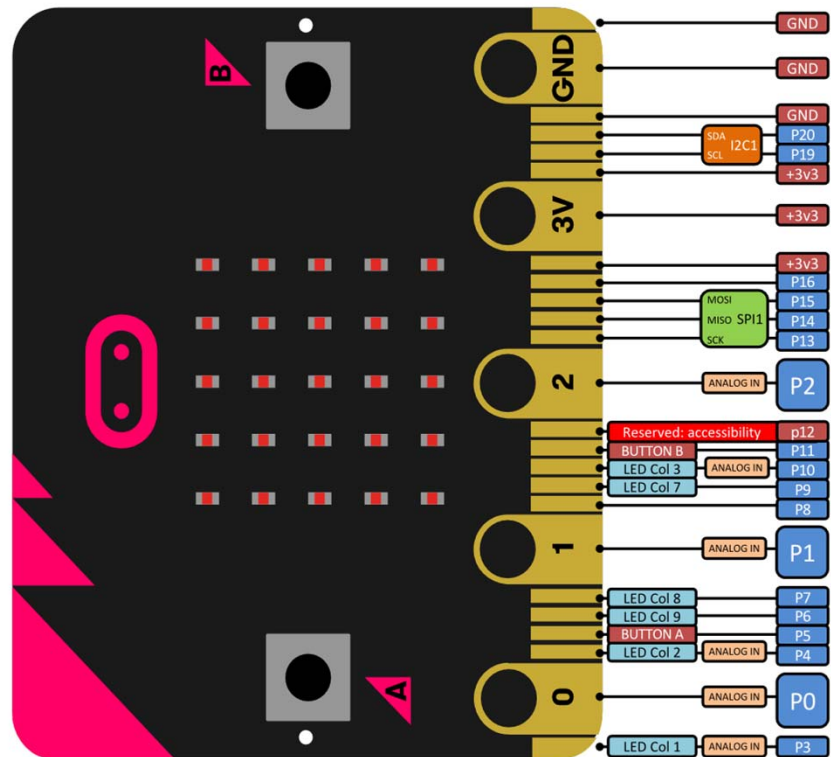

Session #3

Add-ons and 3d Printing

Teacher participants were introduced to exciting micro:bit add-ons and using iPads to control and code the add-ons

In addition, teachers were introduced and given time to explore 3d printing for the micro:bits using TinkerCAD (a free online 3d design application)

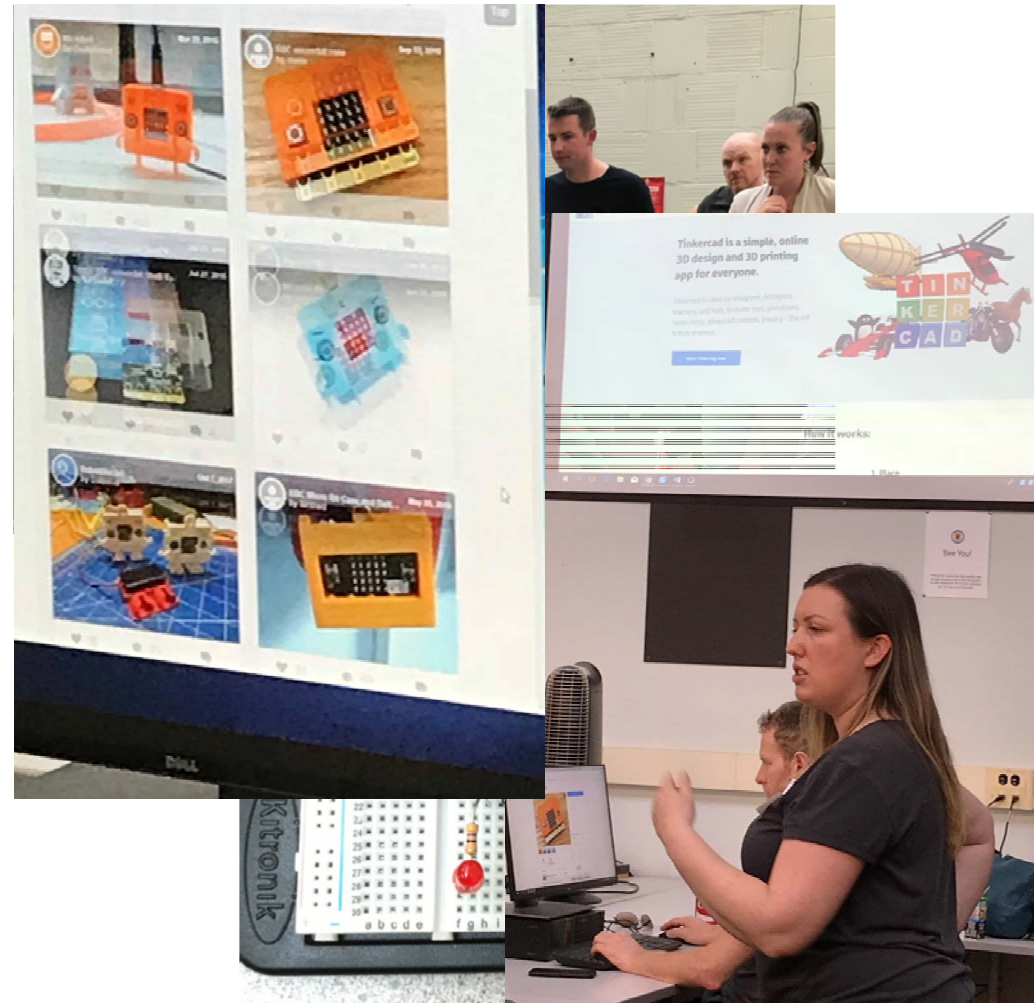

VSB Coding & Computational Thinking – Roadmap



Introduction

Wesley Peregoodoff-Marte

Micro:bit Step Counter

Micro:bit Reaction Timer

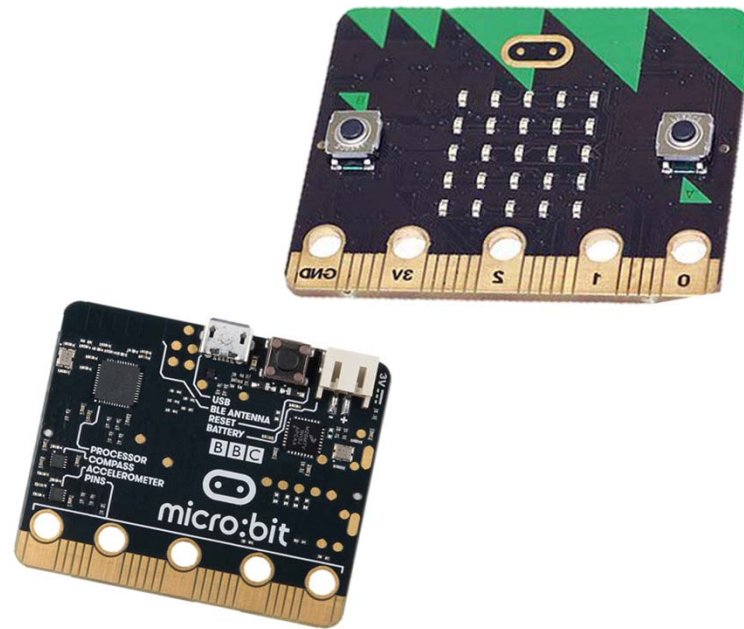

Where are we going?

- Continue to support teachers through workshops and in class support
- Pursue equitable access to micro:bits for students
- Steam Days of Summer at Crosstown with Science World
- Host 3d Printing Summer workshop for teachers
- Develop support materials for using a variety of resources for coding/computational thinking in the classroom (may include Board Games, Vex, Lego Mindstorms, 3D printers, Ozobot, Dash n Dot...)



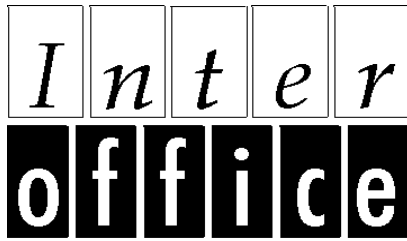

Memorandum

vancouver school board



ITEM 2

June 6, 2018

TO: Committee III – Education and Student Services

FROM: Adrian Keough, Director of Instruction -
Learning Services (Educational Programs)

RE: **French Immersion Program Review**

Reference to Strategic Plan:

Goal 1: Engage our learners through innovative teaching and learning practices

Objective 1: Provide increased opportunities to connect students to their learning

Goal 4: Provide effective leadership, governance and stewardship

Objective 4: Effectively use school district resources and facilities

INTRODUCTION

The Vancouver School District has a strong 40 year history of French Immersion (FI) as a Program of Choice. The French Immersion program has seen continued growth and interest over this time. However, during the last few years the District has been unable to meet demand for French Immersion and has continued to add spaces and sites where possible. Since the 2016 Supreme Court decision and 2017 Memorandum of Agreement (MOA), the District decreased the number of Kindergarten French immersion (KFI) spaces primarily due to a shortage of qualified teachers. In addition, changing demographics across the City have resulted in an imbalance in accessibility to French Immersion programs. For example, one area in the District has waitlists of more than 100 K FI applicants while other areas have waitlists of less than 10 K applicants with FI as their first choice.

In September of 2017 the Board asked District Staff to create a French Immersion Working Group comprised of stakeholder representatives in order to conduct a French Immersion Program Review.

This report outlines the French Immersion Working Group (FIWG) process and provides an overview of findings from this process. This report contains a recommendation.

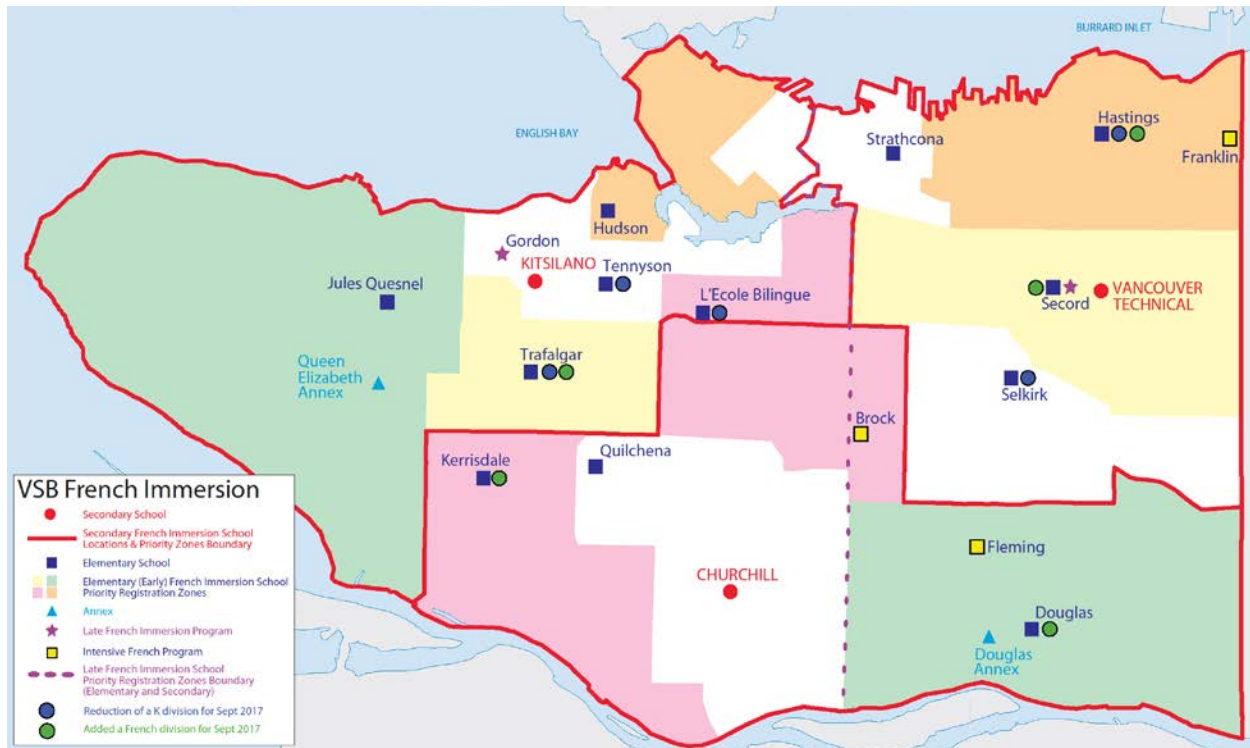

BACKGROUND / HISTORY

In January of 2004, a report ‘Local Area Review of French Immersion Programs and Catchments’ was presented at Committee II and a related motion was approved by the Board on January 14, 2004. One of the recommendations arising from this motion was the creation of a specific French Immersion catchment (this term was changed to Priority Registration Zone or PRZ) for the Kerrisdale Elementary French Immersion program. Since 2004 three additional Early French Immersion (EFI) programs have been added: Lord Selkirk Elementary in 2005, Henry Hudson in 2006 and Lord Strathcona Elementary in 2008.

In May of 2016 the Board approved its [Strategic Plan](#) containing plans to conduct several program reviews including VSB’s ‘Programs of Choice’. FI is one of these Choice programs.

A [May 2017 Committee III](#) report outlined specific changes to FI including the reduction of five EFI K divisions in five different schools. It is important to note that while there were fewer K FI students and divisions in 2017-18, five additional divisions of various grades of EFI were added to comply with the restored class size and composition language, meaning therefore that the total number of French Immersion divisions or classes across the District did not actually decrease although there were fewer students in EFI K.

The May 2017 report stated: “As part of the VSB 2021 Strategic Plan, a review of Programs of Choice (including French Immersion) was already scheduled to take place. This review will include an analysis of the locations of existing programs, as well as whether there are

opportunities for expansion or a need to reduce certain programs in certain areas. In addition, and also part of the VSB 2021 Strategic Plan, staff will complete a catchment area review to analyze any boundary changes that may need to occur. It may be necessary to do a more in-depth school by school facilities review as well, in order to look more closely at how space is allocated within each school. There may also be the need to review and revise certain VBE policies related to catchment areas, programs of choice, etc.”

A [September 13, 2017 Committee III](#) report stated that the FI program review would be completed with the Programs of Choice review in the 2017-18 school year, beginning with an exploration of the K registration process. Given the scope of Choice programs within the District (45 schools host one or more Program of Choice), it was decided to address the French Immersion program review first.

A stakeholder group was struck to review the challenges in meeting demand for K FI and specifically in how the demand relates to the distribution of programs. A committee comprised of VSB stakeholder group representatives met three times between September and November. A report including a recommendation went to the [December 6, 2017 Committee III](#) meeting. The motion to suspend “priority registration zones” as outlined in section 11 of Board Regulation JECC-R for French Immersion for the 2018-19 school year was adopted by the Board on [December 18, 2017](#). During this suspension, families can choose to apply to K FI in any of the schools as their first choice.

One action that came out of this motion was to provide families with more information about anticipated number of available K FI spaces in each school site for the 2018-2019 school year.

Families of elementary FI students were polled in December 2017 to determine if they were planning to apply for K FI for any siblings who would be entering K in September 2018. The estimated number of available spaces for K FI was then shared on the VSB K Choice application website in an effort to inform potential families of spaces at each FI site. This process revealed that the temporary suspension of FI PRZs resulted in only a limited change in the pattern of applications at each FI site (see chart below).

The [February 7, 2018 Committee III](#) report showed the number of siblings anticipated to apply for EFI K for the 2018-19 year. The following table shows the FI K application data for the past five years.

2014-2018 FI K Application Totals

School	Program Type	First Choice Applicants 2014	First Choice Applicants 2015	First Choice Applicants 2016	First Choice Applicants 2017	First Choice Applicants 2018
Jules Quesnel/QE	Early FI	77	100	91	90	86
Tennyson	Early FI	77	71	109	100	60
Hudson	Early FI	56	57	64	64	65
Trafalgar	Early FI	59	39	43	33	29
L'Ecole Bilingue	Early FI	128	121	161	165	172
Kerrisdale	Early FI	46	43	50	30	55
Quilchena	Early FI	38	34	22	33	25
Douglas Annex	Early FI	71	61	75	69	59
Selkirk	Early FI	70	88	67	67	64
Hastings	Early FI	89	93	91	79	49
Laura Secord	Early FI	79	78	90	79	89
Strathcona	Early FI	29	39	32	32	34
EFI Totals		819	824	895	841	787

FRENCH IMMERSION WORKING GROUP PROCESS AND CONSULTATIONS

An additional action from the December 6th Committee III motion was to undertake a French Immersion Program Review as detailed below. The French Immersion Working Group's mandate for the review was: 'Given current challenges facing the VSB French Immersion program, the French Immersion Review will consider enrolment issues, potential alternative delivery models, and program distribution in an effort to assist the VSB in better meeting demand for this very popular choice program'.

The French Immersion Working Group (FIWG) was comprised of:

- VSB Director of Instruction – Education Programs
- Vancouver Secondary Teachers' Association (VSTA)

- VSB Employee Services – Manager of Recruitment
- Trustee
- District Parent Advisory Council (2-5) (DPAC)
- Vancouver Elementary School Teachers' Association (VESTA)
- Vancouver Elementary Principals' and Vice Principals' Association (VEPVPA)
- Vancouver Association of Secondary School Administrators (VASSA)
- VSB Planner in Facilities
- Vancouver District Student Council (VDSC)

The French Immersion Program Review discussions focused on the following questions:

- Key Question: Thinking about the VSB French Immersion program and the issues it faces today, what options could ensure a strong and sustainable French Immersion program?
- Question #1 – What considerations are important to support a successful French Immersion program?
- Question #2 – What delivery models/configuration alternatives would best address these needs and concerns?
- Question #3 – What general criteria should be used to determine the distribution / location of French Immersion sites within the VSB?

The Working Group engaged in four facilitated planning sessions (January 18, February 15, March 15, and May 14, 2018) to:

- Review information regarding the current French Immersion Program
 - Identify draft measures of success
 - Consider potential French Immersion delivery models/configuration alternatives, and
 - Identify and discuss criteria for distribution of French Immersion sites in the District.
1. During the first session on January 18th, 2018 the Working Group reviewed the proposed context for the French Immersion Program Review. A preliminary draft list of measures of success for a successful French Immersion Program was developed as a reference point for the Program Review. The list was later finalized:
 - Student Success – FI Program strengthens fluency and ease with French (oral and written)
 - Access to FI program – FI Program is accessible to all potential students irrespective of individual learning needs, and/or economic or geographic differences
 - Choice program – Students may choose to start or leave the French Immersion program.
 - Qualified teachers – FI Program is delivered by qualified teachers with native-like fluency
 - Strong cohort – FI Program allocates space in each elementary location for sufficient number of students to ensure a strong cohort through to the beginning of high school.
 - Respect for neighbourhood schools and communities – FI Program is located and delivered in a manner that considers and respects neighbourhood schools and communities
 2. During the second session on February 15th, 2018 guest speakers from the UBC Faculty of Education shared current developments and practice regarding French Immersion education and the training of French Immersion teachers, including provisions to assess language proficiency. Following the guest speakers' presentations, the group revised the draft measures of success and conducted a very preliminary review of French Immersion Delivery

Models across Canada. A summary of research regarding French Immersion Program Models was shared with the Working Group during this session (below). Finally, the group discussed preliminary issues and questions to be addressed during consultations with stakeholder groups scheduled for April 2018.

French Immersion Program Models Research (February 2018)

Program Model	Aspects of note
Two year Bilingual Kindergarten	Offered in the Ottawa/Carleton District; <u>all</u> K programs are two year, in which 50% of instruction is in French and the other 50% is in English.
EFI K Start	Students are entirely immersed in French from K-2/3; as they continue their education, the amount of instruction provided in French decreases; this program is found across the country.
EFI Grade 1 Start	In Anglophone East School District in New Brunswick. K is in English and French starts in grade 1
Middle French Immersion starting in grade 3	Offered in New Brunswick, from grades 3-5; 80% instruction is in French. In grade 3, the first 12 weeks are designed to introduce the French language. Math and English Language Arts instruction begin in September. Science, Social Studies and Health instruction begin formally in December in French.
Middle French Immersion starting in grade 4	Manitoba: grades 4-6 all subjects are taught in French except English; grades 7-8 50% of instruction is in French. Ottawa grades 4-6 all subjects taught in French except Math and English, grades 7-8 50% in French.
Late French Immersion starting in grade 6	Offered in many jurisdictions: all subjects taught in French except English.
Late French Immersion starting in grade 7	Offered in the Calgary school district, from gr. 7-9 français, Mathematics, Science, and Socials are taught in French; from grades 10-12 français, Mathematics, and Socials are taught in French.
Decrease % of French taught in each grade.	Calgary: grades 1-2, 100% French; grade 3, 80% French; grades 4-6, 70% French. Ottawa/Carleton: grade 1- 80% in French (Math is taught in English); grades 2-6, 60% in French; grade 7-8, 50% is French.
EFI Single track	An entirely immersive environment. All staff in the building speak French.
Dual track	French Immersion and English tracks share a school. The administrator and support staff do not all necessarily speak French.
Triple Track	Early and Late French Immersion in the same school as well as an English program. The administrator and support staff do not all necessarily speak French.

The following documents were circulated after the February 15th 2018 FIWG meeting:

- An overview of [French Programs in BC](#)
 - Ministry of Education [French Immersion Policy](#)
3. The FIWG spent the majority of the third planning session on March 15th, 2018 discussing a variety of French Immersion Delivery Models, noting the pros and cons of each model in relation to the measures of success. They also discussed considerations related to the distribution of French Immersion sites within the District. Finally, the group discussed options for additional stakeholder consultations for April and or May, 2018.

Working Group members were requested to keep their stakeholder groups informed regarding discussions and progress. FIWG members provided feedback from their respective stakeholder group during the Working Group meetings. Following the third session, the Working Group did not feel that additional broad public consultations was warranted during April 2018. However, they agreed that stakeholder groups could request assistance with focus groups or a survey of members during that time.

Following the third session, an “*Interim Summary of Findings*” was drafted and circulated to the Working Group and stakeholder groups. During late April and early May, 2018, the VSB supported additional stakeholder consultations including focus groups with VASSA, VEPVA and DPAC, and a student survey of secondary students in the three secondary schools that host French Immersion programs. VESTA emailed an “*Interim Summary of Findings*” to members and held a meeting to solicit feedback on those options.

4. The Working Group reconvened on May 14th, 2018 to review and consider feedback and input from the April stakeholder consultation sessions. The group identified additional pros and cons regarding seven preliminary draft options for the reconfiguration of the District’s French Immersion programming.

As a result of the potential for overlapping recommendations from the French Immersion Program Review and the District Catchment Review Process, the FIWG supported a decision to present the FIWG findings and staff recommendations stemming from this work at the June 6th, Committee III meeting rather than October 2018 as originally planned.

The measures of success (listed earlier in the report) were used to analyze the following program delivery models and structures including:

- Early French Immersion – starting in Kindergarten
- Early French Immersion – starting in Grade 1
- Middle French Immersion – starting in Grade 4
- Late French Immersion – starting in Grade 6
- Single Track Schools – only French Immersion in the school
- Dual Track Schools – French Immersion and English in the school
- Triple Track Schools – Early, Late French Immersion and English

FRENCH IMMERSION WORKING GROUP FINDINGS

Table of Options for French Immersion

Note: While there is strong support for certain options over others, the support is not unanimous among all stakeholder representatives. The options are listed in order of support from highest to lowest from both the Working Group as well as the stakeholder consultations.

Option #	Description	Pros	Cons
Endeavour to locate at least two K cohorts at each EFI site	<ul style="list-style-type: none"> Accommodate at least two Kindergarten cohorts at each site 	<ul style="list-style-type: none"> Strengthen size of FI student cohorts through the elementary school years and strengthen teacher cohorts at each FI site 	<ul style="list-style-type: none"> Some FI sites don't have room for 2nd cohort through Grade 7 Number of teachers required would increase
Improve access to EFI through reconfiguration of existing sites to better meet demand (this could mean consolidation, relocation and/or adding new schools)	<ul style="list-style-type: none"> Same number of students as now Reduce number of Early French Immersion sites Reconfigure some sites to address staffing shortages More evenly distribute EFI sites around the District 	<ul style="list-style-type: none"> FI sites distributed more evenly so that all families who want access have a more equal opportunity given current demographics. Endeavour to match the supply of FI sites with levels of demand around the city Consolidates and allocates resources more efficiently (e.g., librarians, resource teachers, and other non-human resources, etc.) 	<ul style="list-style-type: none"> Some neighbourhood schools and students would be impacted by movement of FI program locations
Explore opportunities to increase number of Late French Immersion sites	Assume that additional LFI sites would be placed in sites with EFI program	<ul style="list-style-type: none"> Strong student outcomes and success Students benefit from strength of skills, tools and strategies gained in learning during K-6 Strengthens teacher cohort Students choose LFI Option for families or students who did not choose or were not able to access EFI Opportunity to increase access and demand by adding LFI to current EFI sites 	<ul style="list-style-type: none"> Less diversity due to self-selection "Streaming" within public system Lower levels of interest in LFI historically Increased enrolment in LFI may require more teachers
Temporarily change entry point for Early FI to Grade 1 from Kindergarten	Assumption: This delivery model would result in students being accepted into EFI Grade 1 before starting Kindergarten in English,	<ul style="list-style-type: none"> Addresses teacher shortage (saves 19 teachers positions) Removes need to move students after K 	<ul style="list-style-type: none"> Does not increase number of spaces in EFI Would lose Federal funding for affected K students because

Option #	Description	Pros	Cons
	They would begin school in English with the same cohort that would continue in French Grade 1 in the same school	<ul style="list-style-type: none"> • Keeps students in the public system • High success rates with EFI Grade 1 <ul style="list-style-type: none"> ○ Students ease with learning at that age ○ Students read in English before Grade 1 	<ul style="list-style-type: none"> • 100% instruction in French is required under current agreement for these additional funds • Teachers (FI) have a choice whether or not they want to teach a grade besides K • May lose students to private schools • This option would require additional discussions between VTF and VSB • Would impact the five single track FI schools as the K program would be in English and the rest of the school is FI
Add Middle French Immersion to current suite of FI programs	Middle French Immersion program begins in Grade 4 with an option to have a model similar to Late French Immersion; gradual introduction of English after an immersive French experience	<ul style="list-style-type: none"> • Would provide another option to families who were not able to access KFI • Self-selection could lead to a higher retention 	<ul style="list-style-type: none"> • Grade 4 students have not received French as a second language as core French begins in grade 5 • Therefore not possible to teach grade 4 curriculum in an immersion setting as students don't have necessary French vocabulary • Reduced diversity of learners due to streaming (Only those students who are successful in the English cohort would likely apply) • Reluctance by families to move students • There was very little support for Middle FI

The following options were proposed during the last stakeholder consultation sessions. As a result, there was limited feedback on these options.

1. 50/50 French/English in Intermediate grades – this option would not meet the province's criteria for additional funding due to the amount of instruction in French being too low
2. Revisit French Immersion Priority Registration Zones so that families in each zone has an equal likelihood of acceptance to the program

CONCLUSION

The Vancouver School District continues to be committed to offering a vibrant French Immersion program. While the current situation of not being able to meet the demand of families interested in French Immersion Kindergarten is unlikely to change in the near future, since the teacher shortage is not expected to end soon, the District will continue to explore opportunities to provide viable program locations and the possible addition of classes. District staff will also continue the aggressive recruitment campaign.

Long term recommended options:

1. Endeavor to provide at least two K cohorts at each EFI site (this will involve school information sessions and include the possibility of consolidating, relocating or adding programs).
2. Explore more Late French Immersion locations.
3. Keep priority registration zones suspended for one more year (while District staff look into consolidation, changes in Priority Registration Zones and/or adding programs).

PLAN MOVING FORWARD

1. Identify potential sites for FI program consolidation, relocation or addition.

Timing	Next Steps
June 6th, 2018	Presentation of report at Committee III meeting
June 25th, 2018	Discussion re report recommendations at Board meeting
July- August*	District staff to research and prepare materials for information sessions / consultation
September-October*	School based information sessions / consultation in various sites
November, 2018*	District staff to review and analyze data
November, 2018*	Committee III / Board recommendations regarding French Immersion programming for 2019-2020 school year
January 2019*	Application process opens for September 2019

*subject to Board approval on June 25, 2018

2. Continue the current and explore French Immersion recruitment strategies: a comprehensive report was presented on [April 18, 2018 Committee III IV](#)
3. Follow the developments of the Vancouver School District [Catchment Boundary Review](#)

RECOMMENDATION

IT IS RECOMMENDED THAT the VSB endeavor to enroll two Kindergarten French Immersion divisions in each of the Early French Immersion sites which could involve a combination of consolidating, relocating or adding programs.

French Immersion Program Review

Committee III

June 6, 2018

VSB

We inspire student success by
providing an innovative, caring
and responsive learning
environment



Thank you

- Stakeholder groups
 - DPAC
 - VDSC
 - VESTA
 - VEPVPA
 - VASSA
 - VSTA
- Trustee Alexander
- Employee Services
- Facilities
- Learning Services
- John Dawson, District Principal
- Dorli Duffy, consultant

Overview of presentation

- Background / History
 - FI History
 - Five various Committee reports since May 2017
 - Application data
- Process and Consultations
 - Process – stakeholder group planning sessions
 - Measures of success / program models / options
 - Stakeholder consultation: focus groups / survey
- Findings
 - Options
- Conclusion
- Recommendation

Background / History

- 10% of VSB students in FI in 18 schools
- Last FI program catchment review (now called Priority Registration Zones) was in 2004 to establish Quilchena / Kerrisdale 'boundary'
- Newest programs added
 - 2005 Selkirk
 - 2006 Hudson
 - 2008 Strathcona
- Continued growth
- 2017 first reduction in K FI classes in ten years

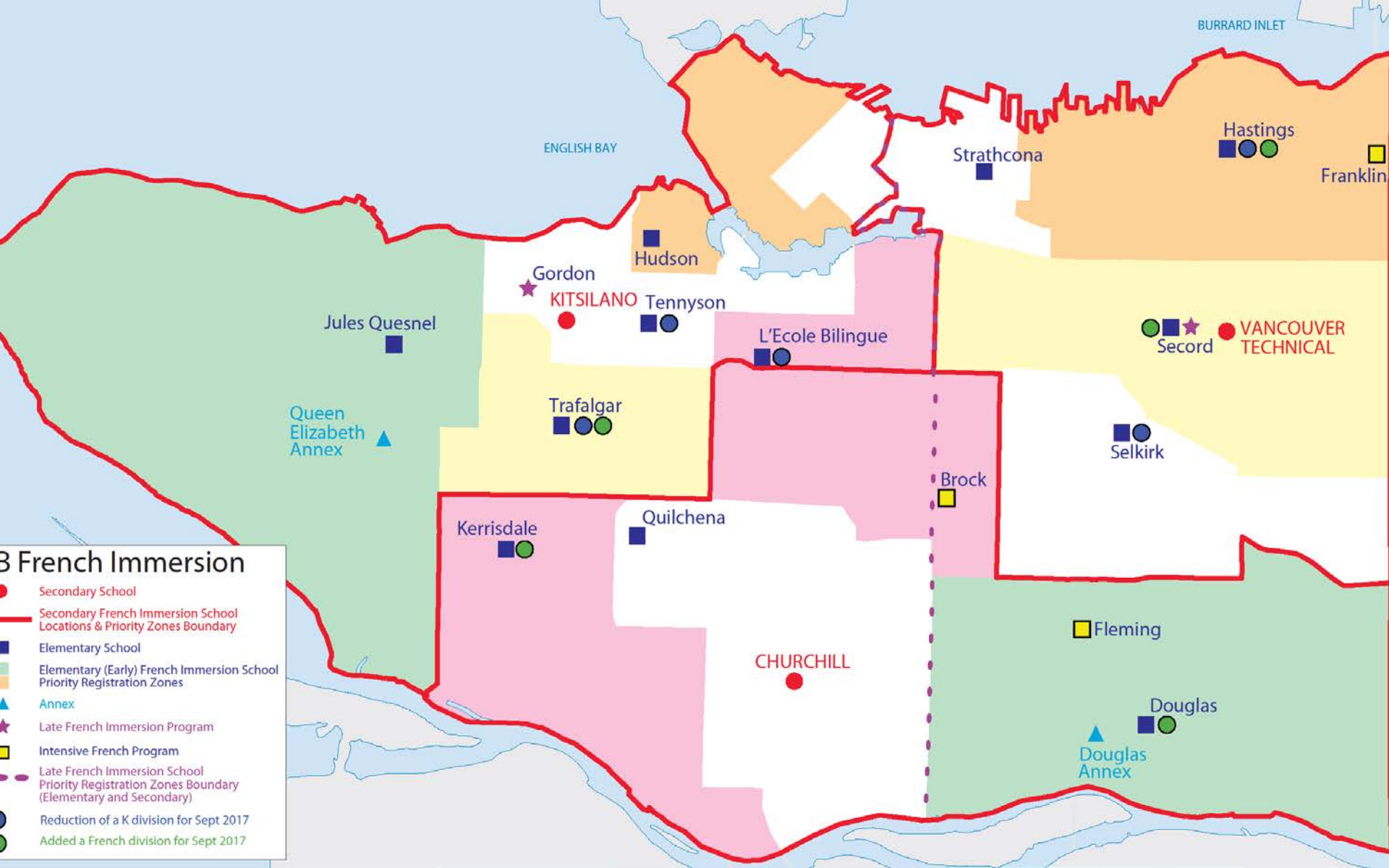

BURRARD INLET

ENGLISH BAY

Strathcona

Hastings

Franklin

Hudson

Gordon

KITSILANO

Tennyson

L'Ecole Bilingue

Secord

VANCOUVER TECHNICAL

Jules Quesnel

Queen Elizabeth Annex

Trafalgar

Selkirk

Brock

Kerrisdale

Quilchena

CHURCHILL

Fleming

Douglas

Douglas Annex

Table of five years of registration data

School	Program Type	First Choice Applicants 2014	First Choice Applicants 2015	First Choice Applicants 2016	First Choice Applicants 2017	First Choice Applicants 2018
Jules Quesnel/QE	Early FI	77	100	91	90	86
Tennyson	Early FI	77	71	109	100	60
Hudson	Early FI	56	57	64	64	65
Trafalgar	Early FI	59	39	43	33	29
L'Ecole Bilingue	Early FI	128	121	161	165	172
Kerrisdale	Early FI	46	43	50	30	55
Quilchena	Early FI	38	34	22	33	25
Douglas Annex	Early FI	71	61	75	69	59
Selkirk	Early FI	70	88	67	67	64
Hastings	Early FI	89	93	91	79	49
Laura Secord	Early FI	79	78	90	79	89
Strathcona	Early FI	29	39	32	32	34
EFI Totals		819	824	895	841	787

VSB EFI simplified waitlist summary 2014-17

School	Program Type	First Choice Applicants 2016	First Choice Accept 20162	First Choice Waitlist 2016	First Choice Applicants 2017	First Choice Accept 2017/18	First Choice Waitlist April 2017	First Choice Waitlist Sep 2017
*Jules Quesnel/QE	Early FI	91	70%	16	90	66%	19	10
*Tennyson	Early FI	109	61%	33	100	40%	59	54
Hudson	Early FI	64	34%	34	64	31%	40	34
Trafalgar	Early FI	43	84%	0	33	61%	13	5
*L'Ecole Bilingue	Early FI	161	41%	84	165	24%	125	124
Kerrisdale	Early FI	50	78%	4	30	127%	0	0
Quilchena	Early FI	22	100%	0	33	61%	9	8
*Douglas Annex	Early FI	75	59%	30	69	58%	27	26
Selkirk	Early FI	67	66%	13	67	30%	47	47
Hastings	Early FI	91	48%	44	79	25%	59	59
Laura Secord	Early FI	90	49%	46	79	51%	37	34
Strathcona	Early FI	32	69%	7	32	63%	11	6
EFI Totals		895	57%	311	841	45%	437	407

Choice Program 2016-17 Kindergarten Applicants for Early French Immersion Program

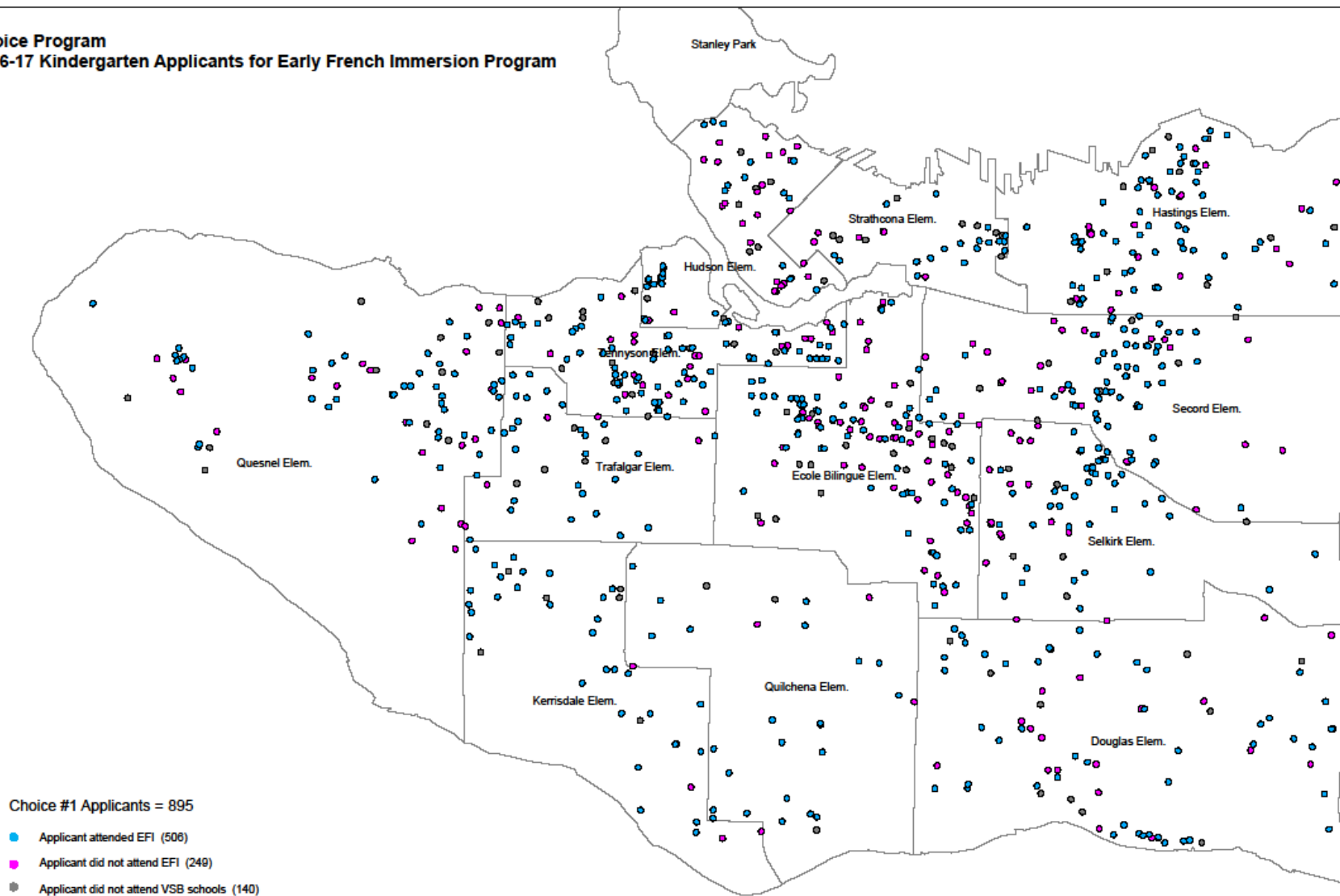

May 2017 until today

- **May 2017 Committee III**
 - Reduction in K intake for 2017-18
- **September 2017 Committee III**
 - Committee struck to review challenges of K EFI intake
- **December 2017 Committee III and The Board**
 - Suspended FI Priority Registration Zones for 2018-2019
- **January 2018** French Immersion Working Group (FIWG) struck
- **February 2018 Committee III**
 - Updates on FIWG
- **April 2018 Committee IV**
 - Recruitment updates for French programs
- **June 2018 Committee III and Board** (pending Committee III support)

French Immersion Working Group mandate

Given current challenges facing the VSB French Immersion program, the French Immersion Review considered enrolment issues, potential alternative delivery models, and program distribution considerations in an effort to assist the VSB in better meeting demand for this very popular choice program.

Considerations

- BC Policy
- VSB policy – catchments
- Collective Agreements
- Timelines
- Availability of FI teachers
- Section 5 of the School Act provides that every student is entitled to receive an educational program that is provided in the English language. Choice Programs, such as French Immersion are based on available space.

Key Question: Thinking about the VSB French Immersion program and the issues it faces today, what options could ensure a strong and sustainable French Immersion program?

- **Question #1** – What considerations are important to support a successful French Immersion program?
- **Question #2** – What delivery models/configuration alternatives would best address these needs and concerns?
- **Question #3** – What general criteria should be used to determine the distribution / location of French Immersion sites within the VSB?

FIWG Committee Representatives

- **Vancouver District Student Council (VDSC)**
- **VSB Employee Services – Manager of Recruitment**
- **Trustee**
- **District Parent Advisory Council (DPAC)**
- **Vancouver Elementary School Teachers' Association (VESTA)**
- **Vancouver Secondary Teachers' Association (VSTA)**
- **Vancouver Elementary Principals' and Vice Principals' Association (VEPVPA)**
- **Vancouver Association of Secondary School Administrators (VASSA)**
- **VSB Planner in Facilities**
- **VSB Director of Instruction – Education Programs**

Process

- 4 meetings 3:45 - 7:15 pm
- Inquiry
- Research, Review, Repeat
- Summary and power points sent out to FIWG members
- Representatives shared with their associations
- UBC Languages / Ed Department guest speakers
- Focus groups
- Student survey

The French Immersion Working Group identified the following *Measures of Success* for a successful French Immersion Program:

- **Student Success** – FI Program strengthens fluency and ease with French (oral and written)
- **Access to FI program** – FI Program is accessible to all potential students irrespective of individual learning needs, and/or economic or geographic differences
- **Choice program** – Students may choose to start or leave the French Immersion program.
- **Qualified teachers** – FI Program is delivered by qualified teachers with native-like fluency
- **Strong cohort** – FI Program allocates space in each elementary location for sufficient number of students to ensure a strong cohort through to the beginning of high school.
- **Respect for neighbourhood schools and communities** – FI Program is located and delivered in a manner that considers and respects neighbourhood schools and communities

Various program delivery models (summary)

- Early French Immersion – starting in Kindergarten
- Early French Immersion – starting in Grade 1
- Middle French Immersion – starting in Grade 4
- Late French Immersion – starting in Grade 6
- Single Track Schools – French immersion only in the school
- Dual Track Schools – an English and a French Immersion program
- Triple Track Schools - an English and a French Immersion program as well as a Late French Immersion program

Options

- Endeavour to locate at least two K cohorts at each EFI site
- Improve access to EFI to better meet demand
- Explore opportunities to increase number of Late French Immersion sites
- Add Middle French Immersion to current suite of FI programs
- Temporarily change entry point for Early FI to Grade 1 from Kindergarten
- 50/50 French in Intermediate Grades
- Revisit French Immersion Priority Registration Zones

Plan Moving Forward (pending Board support)

Timing	Next Steps
June 6th, 2018	Presentation of report at Committee III meeting
June 25th, 2018	Discussion re report recommendations at Board meeting
July- August*	District staff to research and prepare materials for information sessions / consultation
September-October*	School based information sessions / consultation in various sites
November, 2018*	District staff to review and analyze data
November, 2018*	Committee III / Board recommendations regarding French Immersion programming for 2019-2020 school year
January 2019*	Application process opens for September 2019

Conclusion

- VSB continues to be very committed to the FI programs and will continue to explore options to maintain and grow the program as per demand.

Recommendations

- ***IT IS RECOMMENDED THAT*** the VSB endeavor to enroll two Kindergarten French Immersion divisions in each of the Early French Immersion sites which could involve a combination of consolidating, relocating or adding programs.

**2017-18 VSB Early French Immersion Program (EFI)
Priority Zones and Elementary School Catchments**

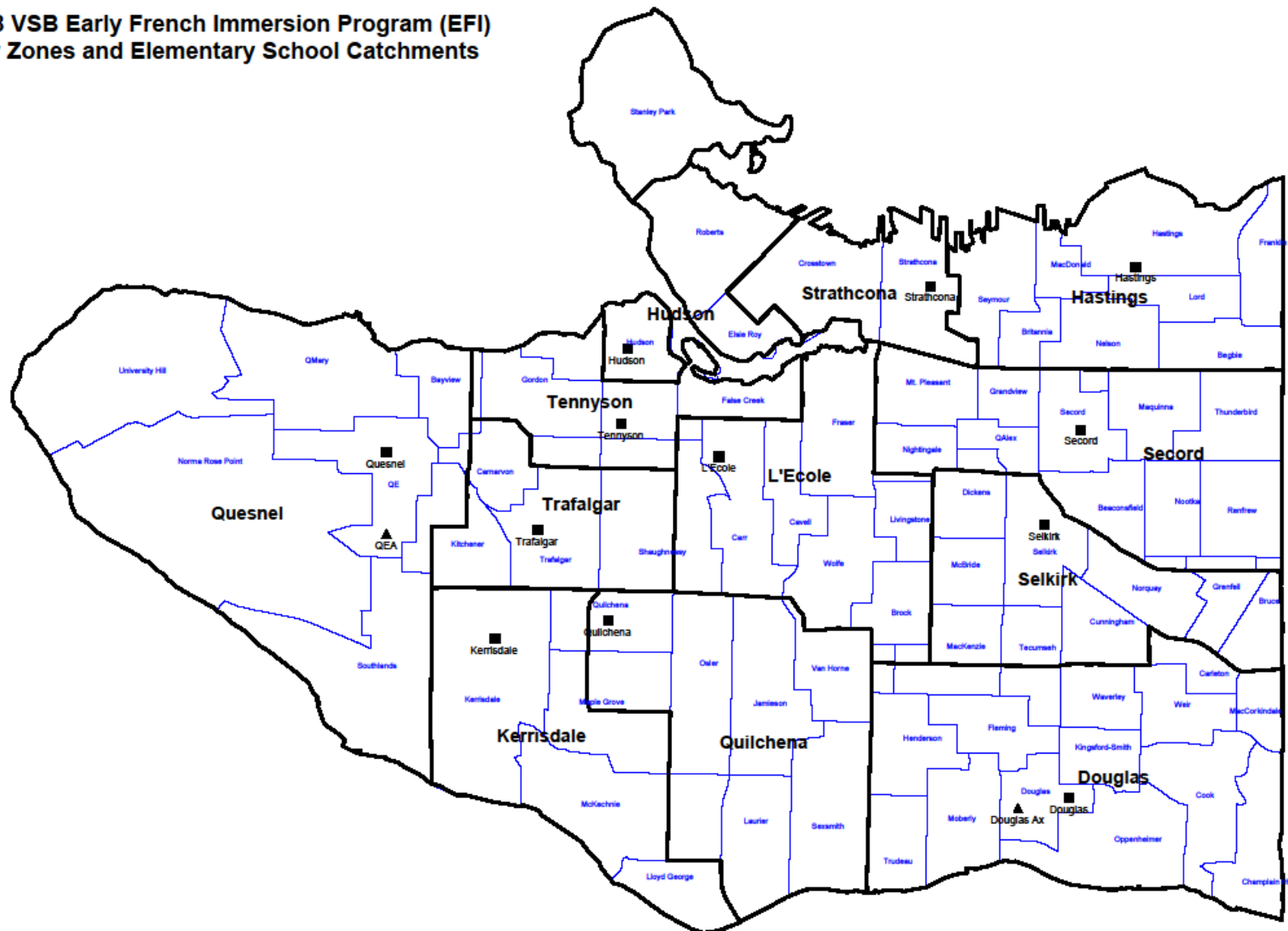

2017-18 VSB Early French Immersion Program (EFI) Percentage of Kindergarten EFI to Total Kindergarten Enrolment

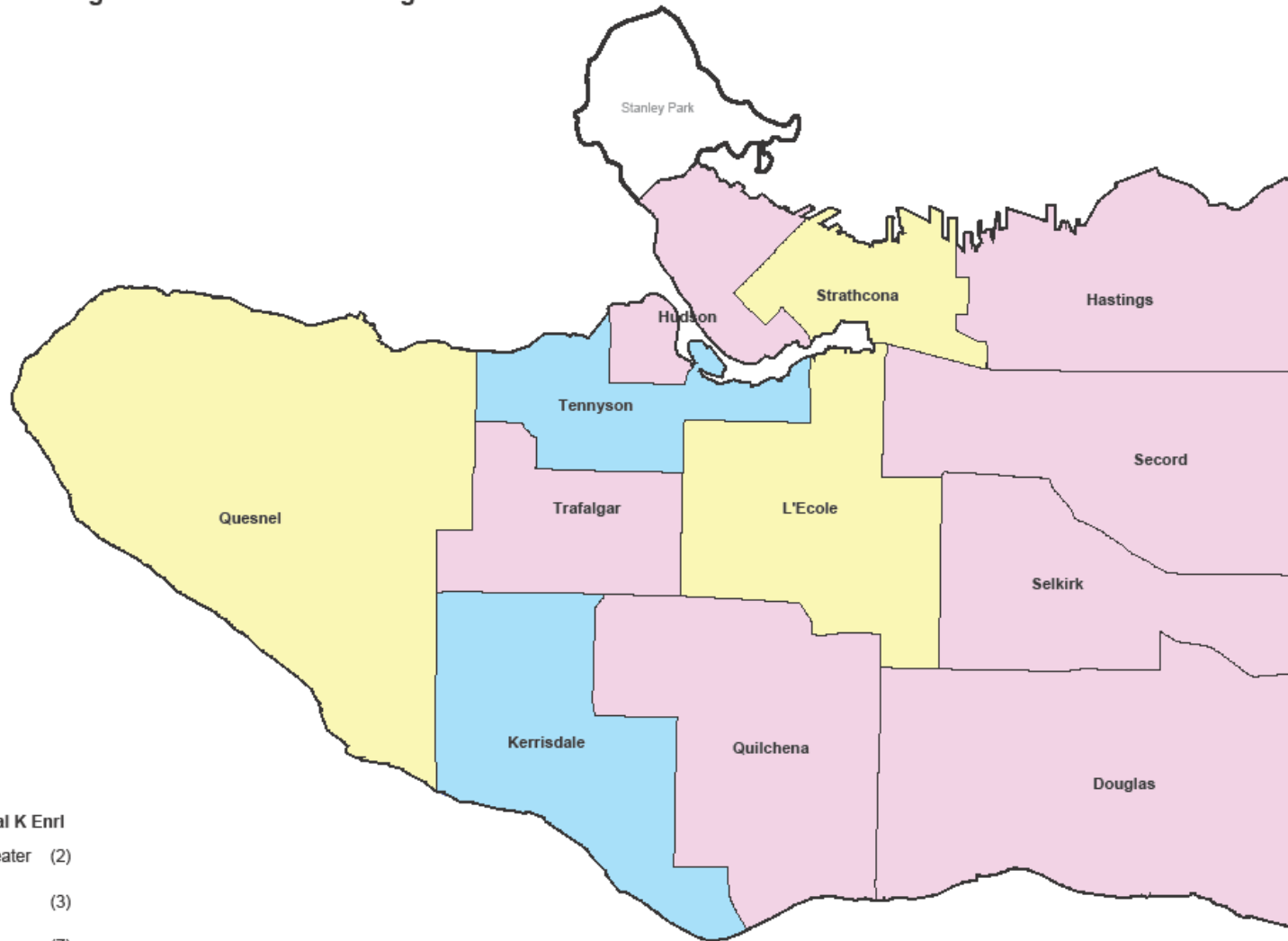

% of K EFI to Total K Enrl

- 21% and greater (2)
- 11% to 20% (3)
- 0% to 10% (7)

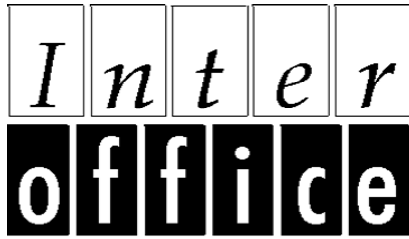

Memorandum

vancouver school board



Date: June 1, 2018

ITEM 3

TO: Committee III – Education and Student Services

FROM: Aaron Davis, Director of Instruction, School Services

RE: **Board/Authority Approved Courses (BAA)**

Reference to Strategic Plan:

Goal #1: Engage our learners through innovative teaching and learning practices.

Objective: Provide increased opportunities to connect students to their learning.

INTRODUCTION:

Board/Authority Authorized Courses (BAA courses) are offered by Boards of Education or Independent School Authorities to respond to the local needs of the schools and their communities while providing choice and flexibility for students. BAA courses are authorized by Boards/Authorities according to requirements set by the Ministry of Education.

BACKGROUND:

All Grade 10 BAA courses that Boards/Authorities wish to offer in 2018/19 need to be revised to align with new Ministry curriculum to reflect the Ministry's Know-Do-Understand curriculum design by July 1, 2018. Remaining Grade 11 and 12 BAA courses that Boards/Authorities wish to offer in 2019/20 will need to be revised by July 1, 2019. Current Grade 10 BAA courses that do not meet the new Ministry criteria will be retired July 1, 2018.

When reviewing revised Grade 10 BAA course proposals, the following Ministry criteria are considered.

- BAA courses may overlap with Big Ideas and Curricular Competencies of Ministry courses.
- BAA courses are not:
 - Courses with significant overlap with provincial curriculum content: This includes adapted courses, partial versions of Ministry courses, and hybrids of two or more Ministry courses.
 - Remedial courses or those preparatory in nature: For example, a math course designed to help students who have completed Foundations of Mathematics and Pre-calculus 10 that provides review and remediation for them before they enroll in Foundations of Mathematics 11; or a writing course designed to help students develop the skills needed to meet the learning standards of Creative Writing 10.

- A modified course: For example, a social studies course designed for Grade 10 students with intellectual disabilities with significantly different learning standards from Ministry Social Studies 10.
- An adapted course: Adaptations are teaching and assessment strategies especially designed to accommodate a student's needs so they can demonstrate that they are meeting the learning standards of the curriculum. A student working to meet learning standards of any Grade or course level may be supported through use of adaptations.

Similarly, guidelines for creating English language acquisition/cultural courses are in place for BAA ELL courses. Existing Grade 10 BAA ELL courses are required to be revised to align with the new curriculum.

Rationale

- Students come from a variety of linguistic and cultural background. BAA ELL course are designed for students whose primary language is not English and may require additional English language support and understanding of local culture to access the B.C. curriculum and reach their potential.
- The objective of BAA ELL course is to help students acquire proficiency in the English language and understanding of Canadian culture:
 - to support the cognitive and academic growth of English Language Learners; and
 - to support the transition of these student into BC schools and their inclusion into and contribution to the ongoing development of Canadian society.

ANALYSIS

One previously approved Grade 10 BAA course and two previously approved Grade 10 BAA ELL courses were revised and submitted for review. The BAA Review Committee, guided by the criteria outline above, reviewed the proposals, provided feedback and opportunities for resubmission. The committee recommends approval of all three proposals. The following courses met the stated criteria:

Computer Hardware 10

This is an introductory course that is geared towards a more hands-on experience and less theoretical compared to higher level courses. Students will learn how to repair and build computers. They will be able to install RAM, hard drives, power supplies and mother-boards. In addition, they will learn how to properly maintain computers to avoid malware attacks, recover data and restore to a prior system state.

Academic Strategies for English Language Learners 10

The course is designed to familiarize and extend a student's abilities to use various strategies independently to meet the learning standards and big ideas and be successful in content-based courses such as English, Social Studies and Science. Emphasis will be on the comprehension of important concepts, linking current information to prior knowledge, and the application of strategies and skills learned. In addition, students will become familiar with a variety of learning skills and Canadian assessment techniques. As well, through discussion and debate, students will learn aspects of the history and culture of Canada.

English Language Development 10

The course is designed to introduce ELL students to the four main English language skills of reading, writing, listening, and speaking. It also encourages the viewing and representation of

materials. The course focuses on developing strategies needed to read, write and extract information successfully in English, and addresses specific needs of students regarding language and culture. Throughout the course students participate in authentic real-life situations. Students demonstrate English language proficiency in oral, visual, and simple written forms using Simple Present, Past, and Future Tenses. Students identify and compare their own customs to Canadian culture and customs.

RECOMMENDATION:

IT IS RECOMMENDED THAT the Board approves the one revised Grade 10 BAA courses, Computer Hardware 10 and the two revised Grade 10 BAA ELL courses Academic Strategies for English Language Learners 10 and English Language Development 10 as submitted.



Memorandum

vancouver school board



June 1, 2018

ITEM 5

TO: Committee III – Education and Student Services

FROM: Rob Schindel, Associate Superintendent

RE: **School Plans Update**

BACKGROUND:

As previously noted in a report to Committee III in June of 2016, beginning in the 2016-17 school year, the Framework for Enhancing Student Learning (FESL) replaces the former Accountability Framework mandated by the Ministry of Education. School Districts across the province have been tasked over the last two years with creating new Framework documents (school and district plans) that best suit the needs of their district.

In Vancouver, all school plans are now on a three-year cycle. The new templates (attached) follow the Spirals of Inquiry Model (Halbert and Kaiser). There is an in-depth version intended for year one of the plan (Appendix A) and shorter versions for years two and three (Appendix B) designed for schools to report out and adapt their plans where needed. This year, most schools were on Year 1 of the three year cycle using the template in Appendix A.

All school plans are currently being reviewed by the Directors of Instruction. The new Framework for Enhancing Student Learning requires that the school plans be “public reports to and for their local community”. Therefore, once approved by their Director, school administrators will upload the final version of their plans to the District portal and to their school websites for public viewing.

All of our schools continue to have a school goal related to Indigenous culture and knowledge:

“To increase knowledge, acceptance, empathy, awareness and appreciation of Indigenous histories, traditions, cultures and contributions among all students.”

In addition to the Indigenous Education goal, most schools have one other goal related to social emotional learning, literacy, numeracy, social responsibility or the core competencies.

This report is provided for information.



Vancouver School District
 School Plan for School Name
 Year 1: 20 of 3 Year Plan, 20 - 20

1. GENERAL SCHOOL STORY (TO BE UPDATED EACH YEAR)

- What are the important demographics of our community?
- What are the unique, positive characteristics of the school?
- What are our assets – what do we celebrate (including student intellectual achievement)?

2. WHAT DO WE KNOW ABOUT OUR LEARNERS? (SCANNING)

- Describe the overall strengths as well as the needs of the learners.
- What is going on for them?

3. WHAT EVIDENCE SUPPORTS WHAT WE KNOW ABOUT OUR LEARNERS? (SCANNING)

- What is the evidence that we already have that supports this hypothesis?
 - School and district data, letter grades, attendance anecdotal, surveys, etc....EDI, MDI, student voice such as TTFM, etc.

4. WHAT FOCUS EMERGES FROM THIS EVIDENCE? (FOCUSING)

- Which learners and which areas will we be focusing on?
- Where are we connected?
 - How does this focus connect to the district strategic plan? (Quote Strategic plan goal/objective #)
 - How does this focus connect to the Aboriginal Education Enhancement Agreement? (Quote AEEA goal/objective)
 - How does this focus connect to the redesigned curriculum including the big ideas, core competencies, curricular competencies, etc.?

5. INQUIRY QUESTION (FOCUSING) – PREVIOUSLY KNOWN AS “GOAL”

- What is leading to this situation for our learners?
- How might we be contributing to this?
- From what we know, what is the most important work that we can do to improve the success for our students?
- What key areas of learning will we focus on?

6. WHAT IS OUR PLAN? (PLANNING)

- What are the actions that we propose to take related to our inquiry. What will we do more of, less of, differently to improve outcomes for our students?
- How can we break it down into a manageable and realistic 3 year plan:
 - Year 1, Year 2 , Year 3

7. WHAT SUPPORTS WILL WE NEED? (PLANNING)

- Summarize what the new areas of learning will be and how we will support that new learning in order to benefit the students (i.e. resources, pro-d, etc.).
- Link these new areas of learning to the redesigned curriculum

8. HOW WILL WE KNOW WE'RE SUCCESSFUL? (CHECKING)

- How will we know that what we are doing is working and is making a difference for our learners?
- What will we be using as baseline data? How will we chart growth?
- How will we respond if we see no changes?

9. HOW WILL WE SHARE THIS INFORMATION? (CHECKING)

- How will we make parents, students and other members of the community aware and involved?



District-wide Aboriginal Goal: To increase knowledge, acceptance, empathy, awareness and appreciation of Aboriginal histories, traditions, cultures and contributions among all students.

10. WHAT DO WE KNOW ABOUT THE ABORIGINAL LEARNERS IN OUR SCHOOL?

- Include numbers of students, grade levels, etc.

11. WHAT HAVE WE DONE AT OUR SCHOOL TO SUPPORT ALL LEARNERS IN REGARDS TO THIS GOAL?

- List examples of pro-d, special events, speakers, curricular integration, routines and customs, etc.

12. WHAT WILL WE CONTINUE TO DO IN THIS AREA?

- List continuing and new initiatives

13. HOW DO WE KNOW THAT WE ARE BEING SUCCESSFUL IN THIS AREA?

- Include both data-driven and anecdotal examples
- Give opportunities for student, staff and parent voice



Vancouver School District
School Plan for School Name
Year 2 or 3 (20) of 3 Year Plan, 20 - 20

1. GENERAL SCHOOL STORY:

- Update school context if necessary
- Review inquiry question and where the need for this goal came from (evidence, etc.)

2A. WHAT DID WE SEE?

- Describe the overall strengths as well as the needs of the learners.
- What is going on for them?

2B. WHAT DO WE NEED TO RE-ADJUST?

- Outline any changes or adaptations from previous plan. Be sure to include rationale for why these changes should be made and how you believe that it will help.

3. INQUIRY QUESTION (previously known as "Goal")

- Does the original question need to be readjusted/continued/changed given the results outlined above?

4. WHAT IS YOUR NEW PLAN?

- Explain plan (i.e. specific activities for year 2) and any changes from previous plans

5. WHAT SUPPORTS WILL WE NEED?

- Review and revise support plans for this year

6. HOW WILL WE KNOW WE'RE SUCCESSFUL?

- Revise (If necessary) or repeat indicators from previous plan

7. HOW WILL WE SHARE?

- How will we make parents, students and other members of the community aware and involved?



District-wide Aboriginal Goal: To increase knowledge, acceptance, empathy, awareness and appreciation of Aboriginal histories, traditions, cultures and contributions among all students.

8. WHAT DO WE KNOW ABOUT THE ABORIGINAL LEARNERS IN OUR SCHOOL?

- Include numbers of students, grade levels, etc.

9. WHAT HAVE WE DONE AT OUR SCHOOL TO SUPPORT ALL LEARNERS IN REGARDS TO THIS GOAL?

- List examples of pro-d, special events, speakers, curricular integration, routines and customs, etc.

10. WHAT WILL WE CONTINUE TO DO IN THIS AREA?

- List continuing and new initiatives

11. HOW DO WE KNOW THAT WE ARE BEING SUCCESSFUL IN THIS AREA?

- Include both data-driven and anecdotal examples
- Give opportunities for student, staff and parent voice

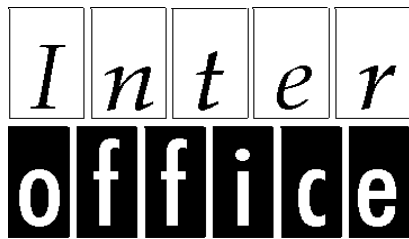

Memorandum

vancouver school board



June 1, 2018

ITEM 6

TO: Committee III – Education and Student Services

FROM: Jody Langlois, Associate Superintendent

RE: **Vancouver Board of Education Archives and Heritage Committee**

Reference to Strategic Plan:

Goal 3: Create a culture of care and shared social responsibility.

Objective 6: Support collaborative relationships with community partners that enhance student learning and well-being.

INTRODUCTION:

Beginning in 2004, a group of retired teachers and administrators began volunteering their time to preserve the history and legacy of the Vancouver School District. Initially, the goal was to establish a Heritage Centre that would be open to the public. Visitors would be able to view historical photos, documents, and artifacts on the history and accomplishments of the public education system in Vancouver.

BACKGROUND:

The creation of such a centre remains an ambition. However, for the past several years, efforts have focused on creating a digital archive drawn from photos and documents collected by the Vancouver School Board and stored at the VSB Education Centre. More recently, priority has been given to designing and building a Heritage website, drafting a Heritage policy for the Vancouver School District, and supporting schools in their efforts to build their own archives/heritage centres.

Recently, Vancouver School District staff have been in discussion with the Heritage Committee members regarding how the District might support the group's efforts. The Heritage group is asking the District to create an internal cataloguing system to store their digital collection. They are also requesting assistance with moving that digital collection into the new cataloguing system, and are looking for schools to actively participate in adding digital items from their sites to the new catalogue system.

It is the hope of the group that the new technology will allow for greater collaboration in the process of archiving items so that they are part of the history of the VSB. For more information about the VSB Archives and Heritage Committee please go to <https://www.vsb.bc.ca/VSBheritage>.

CONCLUSION:

Brian Kuhn, Director of Technology and Chief Information Officer, has heard the group's request and has agreed to work with the Committee to get the project started in the fall of 2018.

This report is provided for information.